

KUBOTA SVL75



75HP



DIMENSIONS & RANGE

Overall Length:	3576mm
Overall Width:	1735mm
Overall Height:	2083mm
Overall Weight:	4100kg
Ground Clearance:	296mm

















FEATURES

 UHF RADIO	 SQUAWKER	 REFLECTIVE TAPE	 EMERGENCY STOP
 LOCKABLE ISOLATER	 AIR CONDITIONING		

COMPLIANCE

					
DAILY CHECKLIST	FIRE EXTINGUISHER	OPERATOR'S MANUAL	PLANT ASSESSMENT	REVERSE BEEPER	ROTATING BEACON

COMPATIBLE WITH

 AUGER DRIVES	 PALLET FORK	 SMUDGE BAR	 AUGER	 BROOMS	 TRENCHER
 ROTO TILLER	 POST DRIVER	 LASER GRADER	 SLASHER	 SIEVE BUCKET	
 GRAPPLE BUCKET	 HARLEY RAKE	 JACK HAMMER	 STICK RAKE	 RIPPERS	

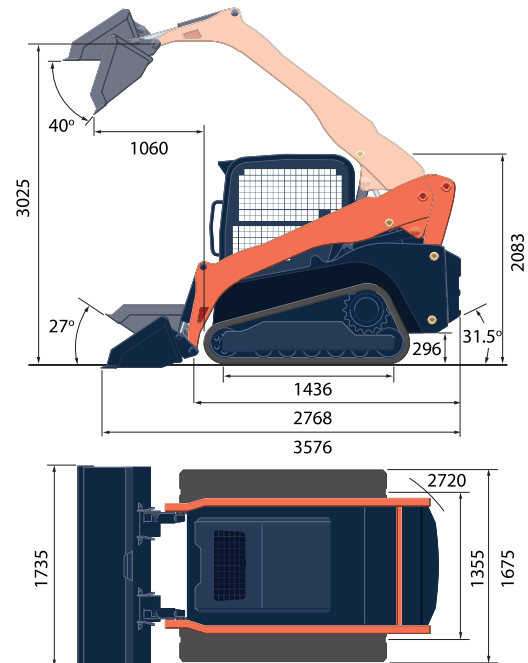

Unit: mm